

PROVEN LEADERS IN 3D SCANNING AND INSPECTION

FOR THE AUTOMOTIVE INDUSTRY

Gocator®

CONTENTS

- 3 WELCOME TO FACTORYSMART®
- 4 THE CHALLENGES IN AUTOMOTIVE INSPECTION
- 5 ACHIEVE YOUR MANUFACTURING GOALS
- 6 GOCATOR FOR SMART AUTOMATED QUALITY CONTROL
- 7 REALIZE THE BENEFITS OF SMART 3D
- 8-9 GOCATOR LASER PROFILERS - FOR INSPECTION OF FAST-MOVING PARTS
- 10-11 GOCATOR SNAPSHOT SENSORS - FOR INSPECTION OF PARTS WITH START/STOP MOTION
- 12 ROBOTIC VISION GUIDANCE AND INSPECTION APPLICATIONS
- 13 GAP & FLUSH APPLICATIONS
- 14 VEHICLE EMBLEM INSPECTION APPLICATIONS
- 15 FIXED MEASUREMENT AND HIGH TOLERANCE APPLICATIONS
- 16 CUSTOMIZED SOLUTIONS: GOCATOR VOLUME CHECKER

WELCOME TO FACTORYSMART®

Achieve Optimal Form and Fit

LMI Technologies has a proven track record of supplying leading-edge, high-performance 3D scanning and inspection solutions **for the many different types of stations in the automotive manufacturing process**, including tooling, framing, assembly, and inspection.

VEHICLE MANUFACTURING

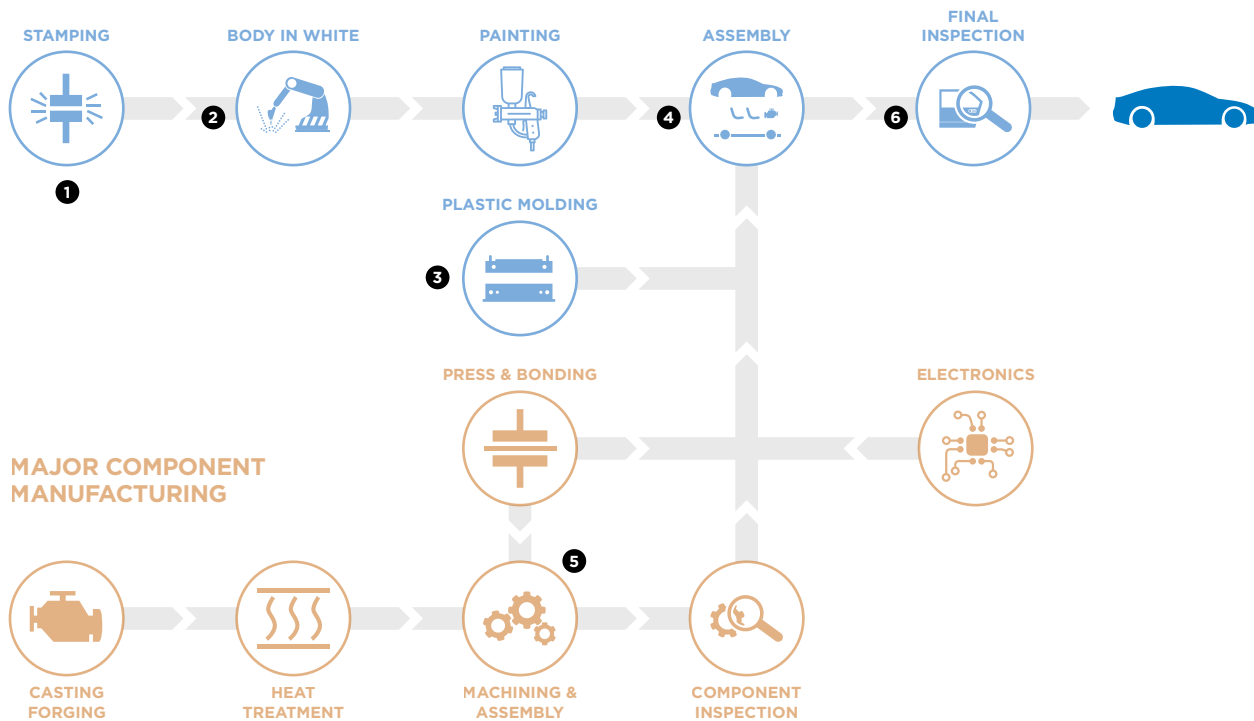

1
Gocator 3210 verifies quality of stamped, forged, and cast parts.

2
Gocator 2430/2440 automates the inspection of body-in-white.

3
Gocator 3506 inspects the surface of plastic moldings such as dashboards.

4
Gocator 3210 inspects quality of components that are pressed or bonded together.

5
Gocator 3210 inspects a variety of machined components before final assembly.

6
Gocator 3210 performs final inspection of vehicles, such as gap and flush.

THE CHALLENGES IN AUTOMOTIVE INSPECTION

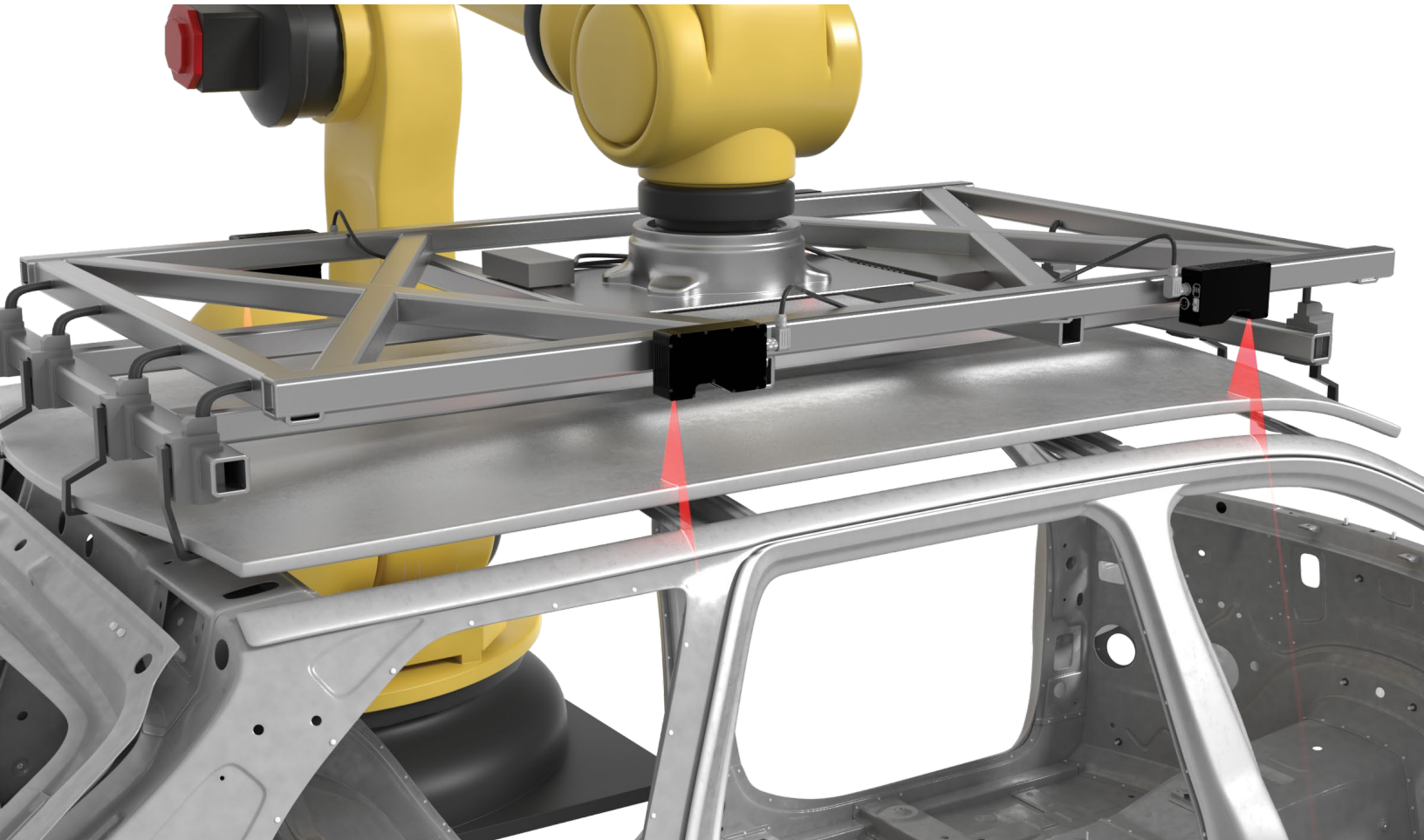

Automation presents a number of challenges for quality control in the automotive industry. These factory processes require an advanced 3D machine vision solution to maximize efficiency, lower cost, and increase yield.

FLEXIBLE AUTOMATION

This is the ability for a robot or system to be quickly and easily re-tasked on-the-fly. Flexible automation requires the solution to have the ability to sense, think, and act—and ultimately adapt to changes in manufacturing.

BETTER QUALITY CONTROL

As for any industry, the goal in automotive is to achieve 100% quality control. This means scanning and inspecting every single part and assembly on the line, not first article inspection (FAI) or random inspection. Data gathered during the scanning and inspection cycle is used to make pass/fail decisions on vehicle **components, assemblies, and final finish.**

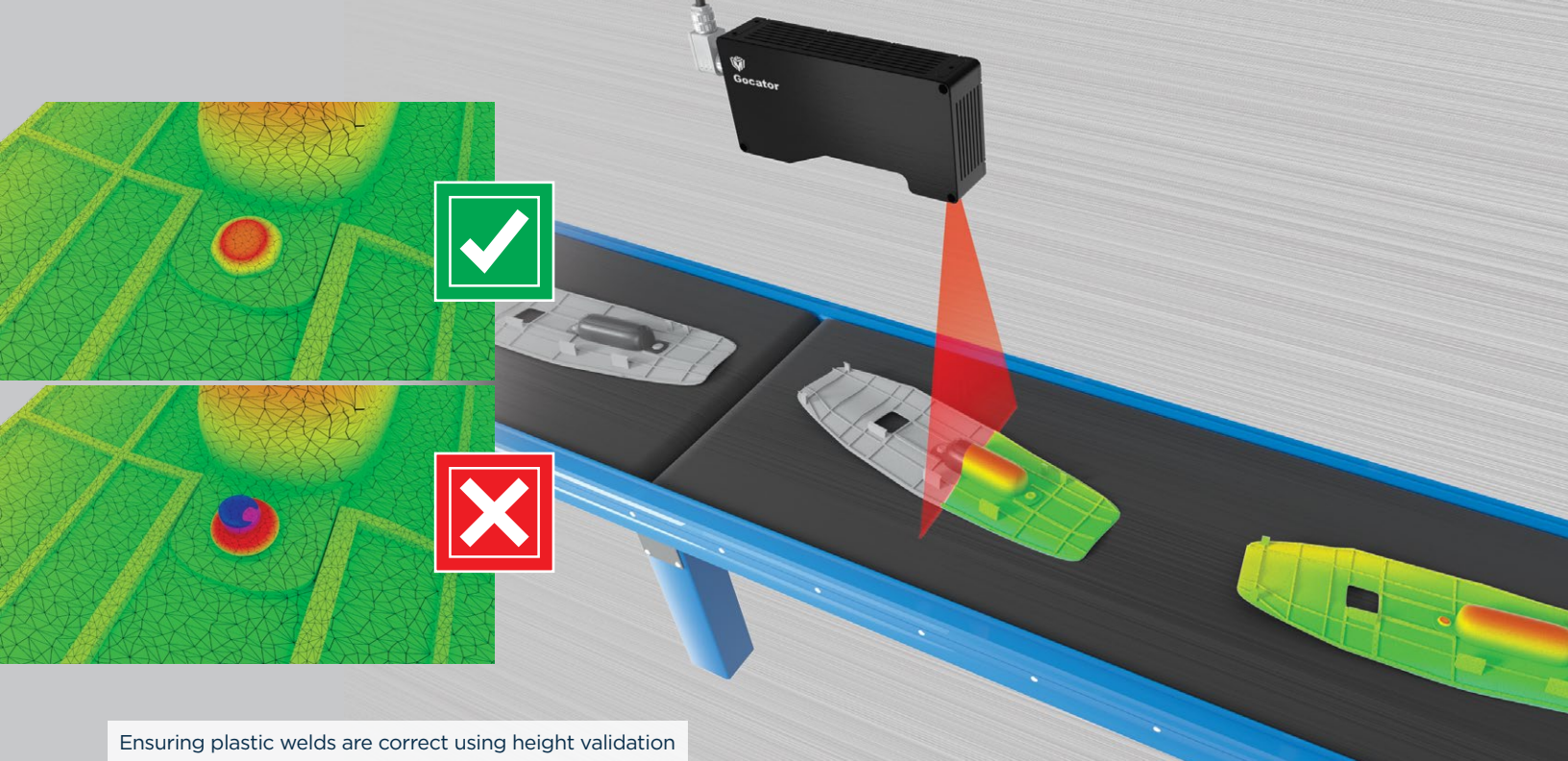

Ensuring plastic welds are correct using height validation

ACHIEVE YOUR MANUFACTURING GOALS

You're looking to make your factory smarter. But what exactly does that mean?

Smart manufacturing means to:

- » Operate More Efficiently
- » Get Products to Market Faster and More Profitably
- » Reduce Waste/Rework of Parts
- » Minimize Product Recalls
- » Increase Manufacturing Flexibility (e.g., enable multi-model production lines)



Automotive Companies Using Gocator

VOLVO



HONDA

CHRYSLER



GOCATOR FOR SMART AUTOMATED QUALITY CONTROL

Gocator 3D smart sensors provide a complete solution for 3D scanning, measurement, and control in automotive factory automation processes.

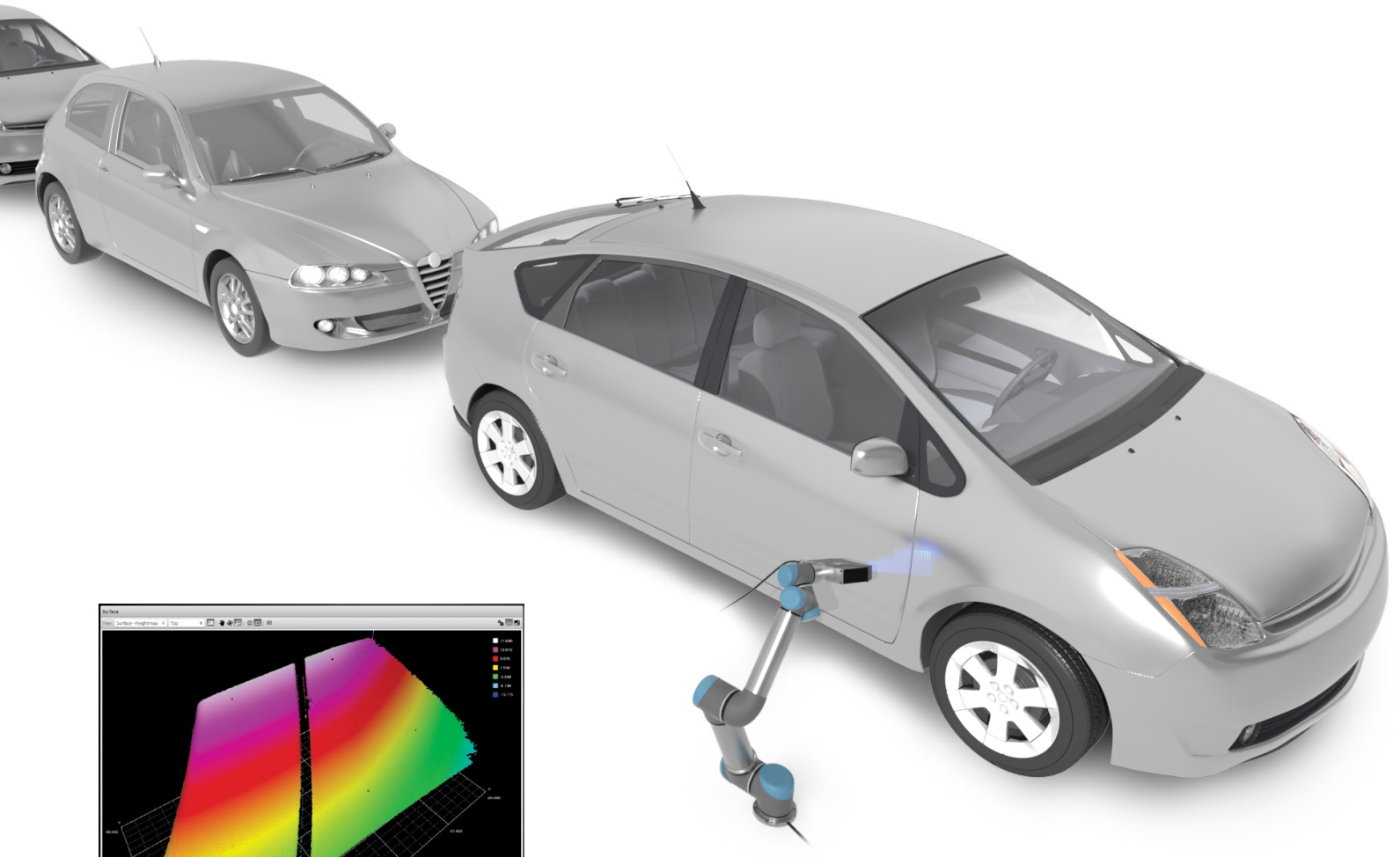

FROM PHYSICAL TO DIGITAL

The smart 3D solution is simple and highly effective. Gocator scans physical targets and digitizes them into 3D. This allows manufacturers to make measurements in the digital realm, execute control decisions, and achieve high quality outcomes in the real world.

QUALITY CONTROL DECISION-MAKING

Gocator makes critical pass/fail decisions and communicates this directly to factory networks and equipment—all within a single package, and all at production speed.

REALIZE THE BENEFITS OF SMART 3D

Gocator makes manufacturing FactorySmart®.

COMPLETE 3D INSPECTION. BUILT-IN.

Inspection is a multi-step process. First, the target is digitized in 3D. Then it is measured to verify critical tolerances are met. Finally a control decision is communicated—either to a robot, PLC, or factory process control monitoring systems. What makes Gocator smart is that it has all of these capabilities onboard, which minimizes system cost and complexity and helps manufacturers reach their goals.

WEB-BASED USER INTERFACE

Gocator offers an easy-to-use web-based user interface that requires no special training. Simply open your favorite web browser to access and control the Gocator, and communicate directly to factory equipment. Leverage a point-and-click design with effective 3D visualization using responsive pan, zoom, and rotate navigation.

NETWORK CONNECTED

Gocator can adapt to changing inspection requirements because it is connected to the factory network, and can easily be updated with new firmware. New firmware can introduce custom measurement tools developed by the process engineering group overseeing the factory environment so that a new process or part receives proper inspection.

ROBOT-FRIENDLY

Gocator offers built-in support to work with robots directly and enable a fully functional multi-model production line to work at a much faster, more efficient pace than traditional single-model assembly lines.

FLEXIBLE DESIGN FOR MULTI-MODEL PRODUCTION

Gocator 3D smart sensors can be “reprogrammed” on-the-fly by loading different “job” files that correspond to each model in a multi-model production line. A job file contains the specific settings for measurements, exposures, and pass/fail criteria.



GOCATOR LASER PROFILERS

3D SMART SENSORS

Gocator laser line profile sensors are ideal for **simple component and assembly inspection** in robotic and fixed measurement applications. Choose these sensors when you need to verify correct dimensions such as standoff, size, and position.

- » PRE-CALIBRATED TO SCAN AND MEASURE OUT-OF-THE-BOX
- » AVAILABLE IN VARIOUS MODELS, WITH FIELDS OF VIEW RANGING FROM 10mm TO 1.26m
- » BUILT-IN TOOLS AND NETWORK PROTOCOLS, NO PROGRAMMING



ROBOTIC INSPECTION READY.

The advantage of Gocator laser line profilers is their size, speed, and resolution. With several series spanning 640, 1280, and 2000 point density, Gocators are small enough to fit on robotic arms and fast enough to keep up with moving vehicles or cycle times involving hundreds of measurements.

For robot guidance, there are several insertion functions that can be performed using a Gocator laser profiler, including: **roof insertion, glass insertion, and panel insertion.**

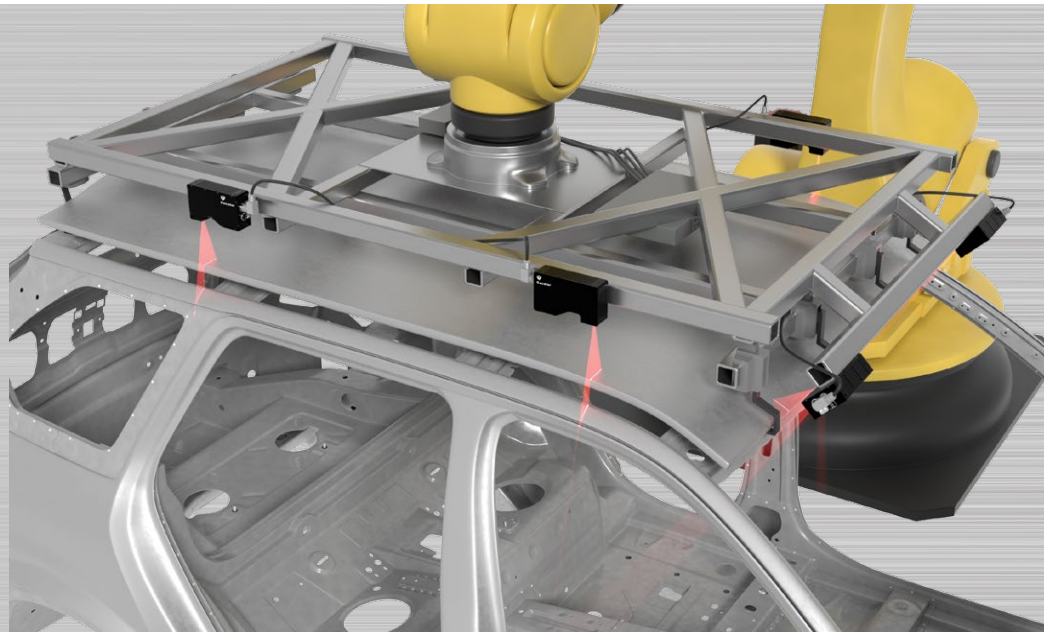

INSPECTION OF FAST-MOVING PARTS APPLICATIONS

Verifying the surface finish
on a brake rotor

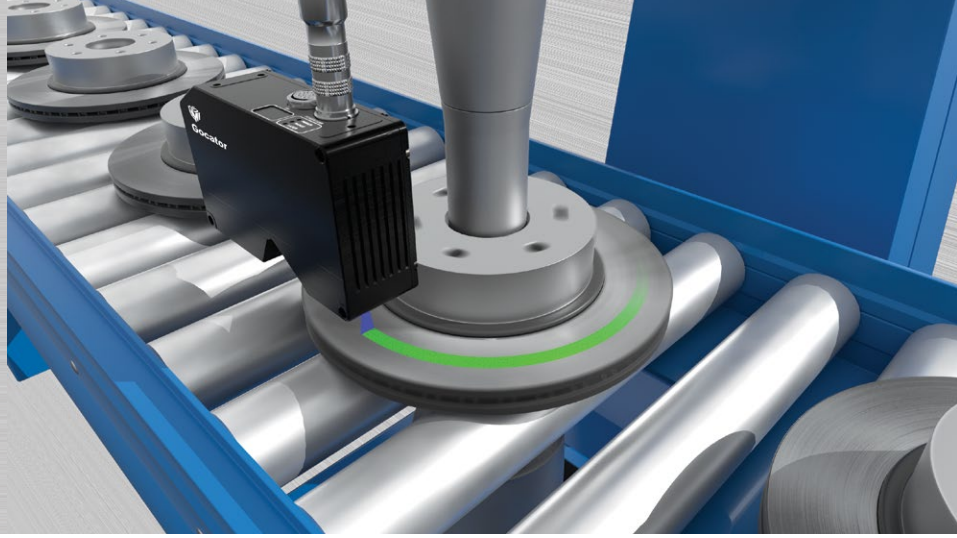
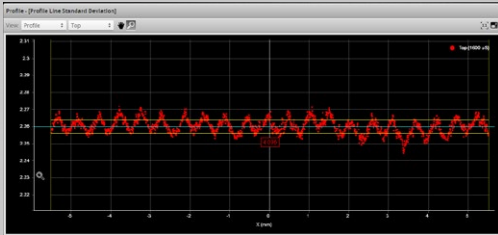

Ensuring sideframe
mounting holes are
the right size and in the
right position

Ensuring stamped parts are
the right size and shape

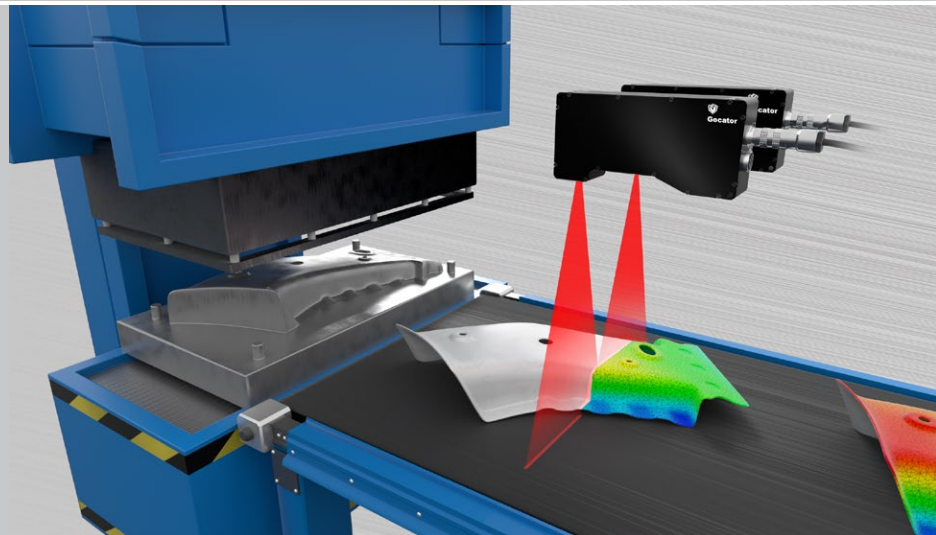

GOCATOR SNAPSHOT SENSORS

3D SMART SENSORS

Gocator 3D snapshot sensors use structured light (fringe projection) to deliver **advanced 3D inspection** of automotive parts, assemblies, and final fit and finish. These sensors are ideal for robotic vision guidance (RVG), **flexible robotic inspection**, **fixed measurement** and **high-tolerance inspection** applications.

- » COMPLETE 3D POINT CLOUD IN A SINGLE SNAPSHOT
- » IDEAL FOR ROBOTIC INSPECTION APPLICATIONS
- » ACCURATE 3D MEASUREMENT WITH BLUE-LED PATTERN PROJECTION
- » INDUSTRIAL DESIGN FOR LONG LIFE

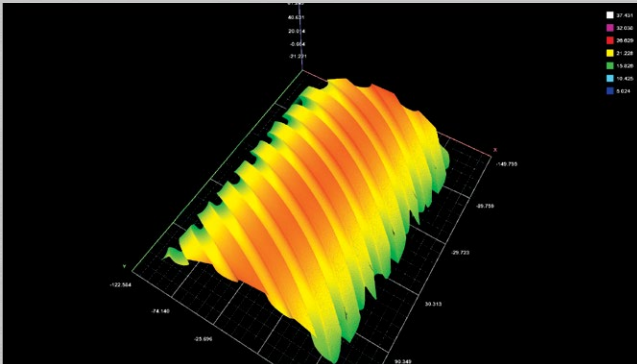

A structured light scanner digitizes an entire area into a 3D point cloud by projecting several light patterns in a rapid sequence onto a stationary surface. These systems can be mounted onto robots for flexible inspection applications, or to inspect larger objects like automotive panels by taking multiple snapshots from several zones.

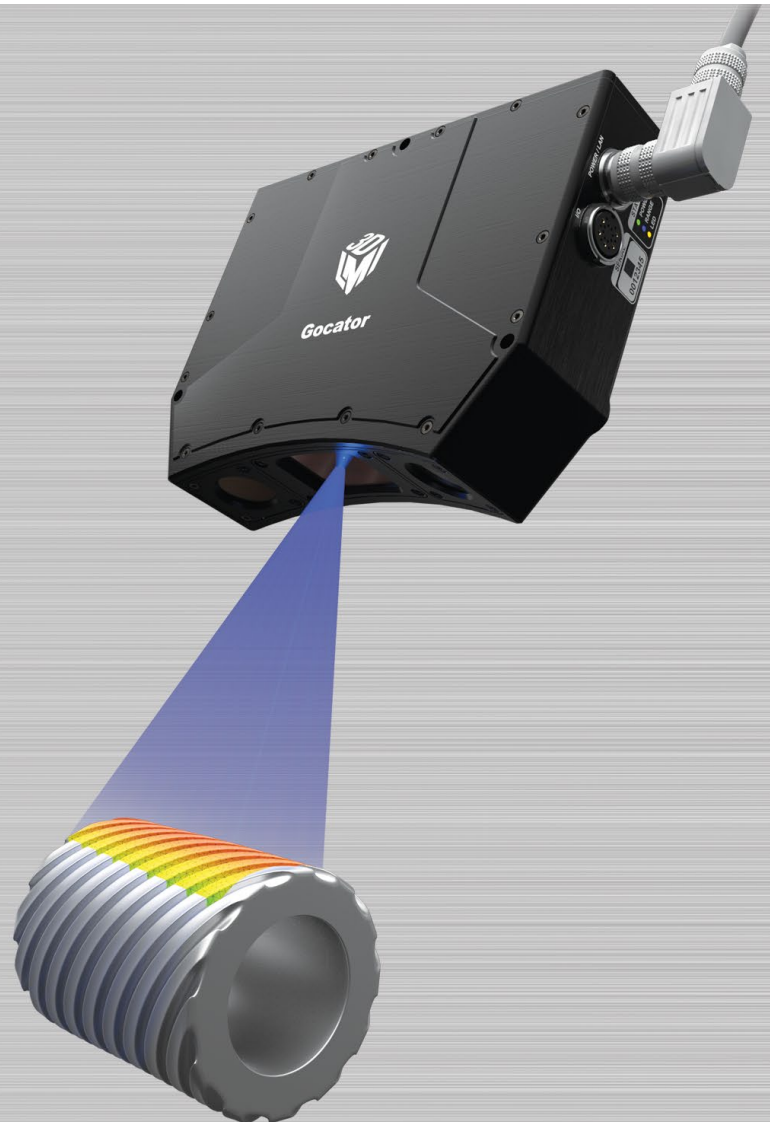

INSPECTION OF PARTS WITH START/STOP MOTION CAPABILITIES

HIGH-SPEED. RICH DATA.

Structured light (fringe projection) systems deliver high-speed, data-rich inspection in the automotive industry. The advantage of these systems is they are able to collect data from an area on a surface and calculate full surface orientation (plane angles).

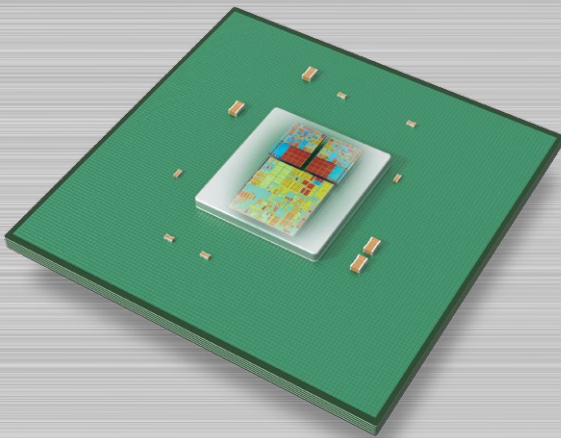
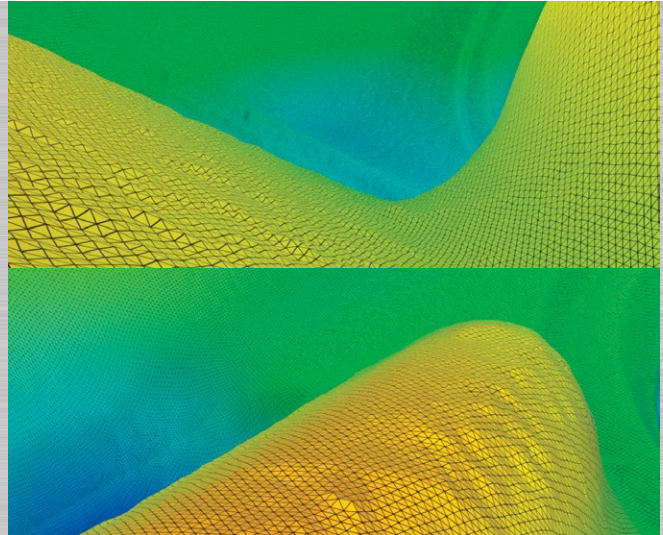

BUILT-IN HARDWARE ACCELERATION FOR FAST INLINE PROCESSING

Gocator snapshot sensors perform 3D point cloud generation directly in FPGA hardware to offer fast cycle times. This provides maximum throughput by optimizing acquisition and processing onboard the sensor.

BUILT-IN 3D MEASUREMENT TOOLS

Gocator snapshot sensors come with built-in measurement tools specifically for common automotive applications, including stud size and orientation, opening sizes, and panel gap & flush.

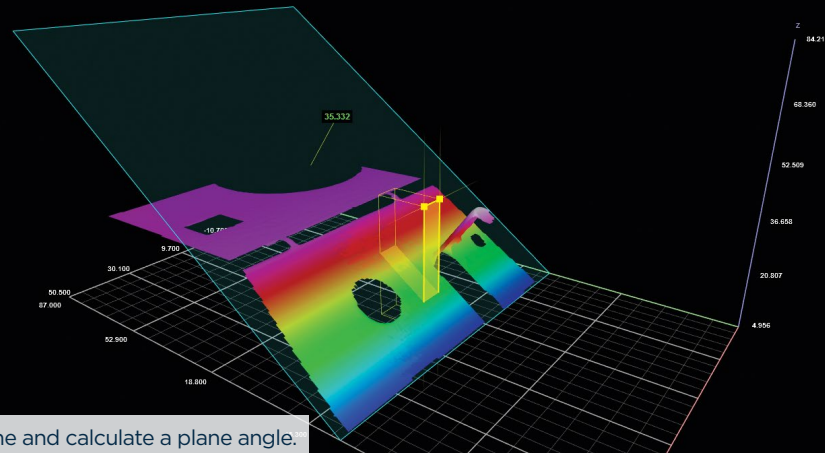

The built-in Surface Plane tool is used to fit 3D points to a plane and calculate a plane angle.

ROBOTIC VISION GUIDANCE AND INSPECTION APPLICATIONS

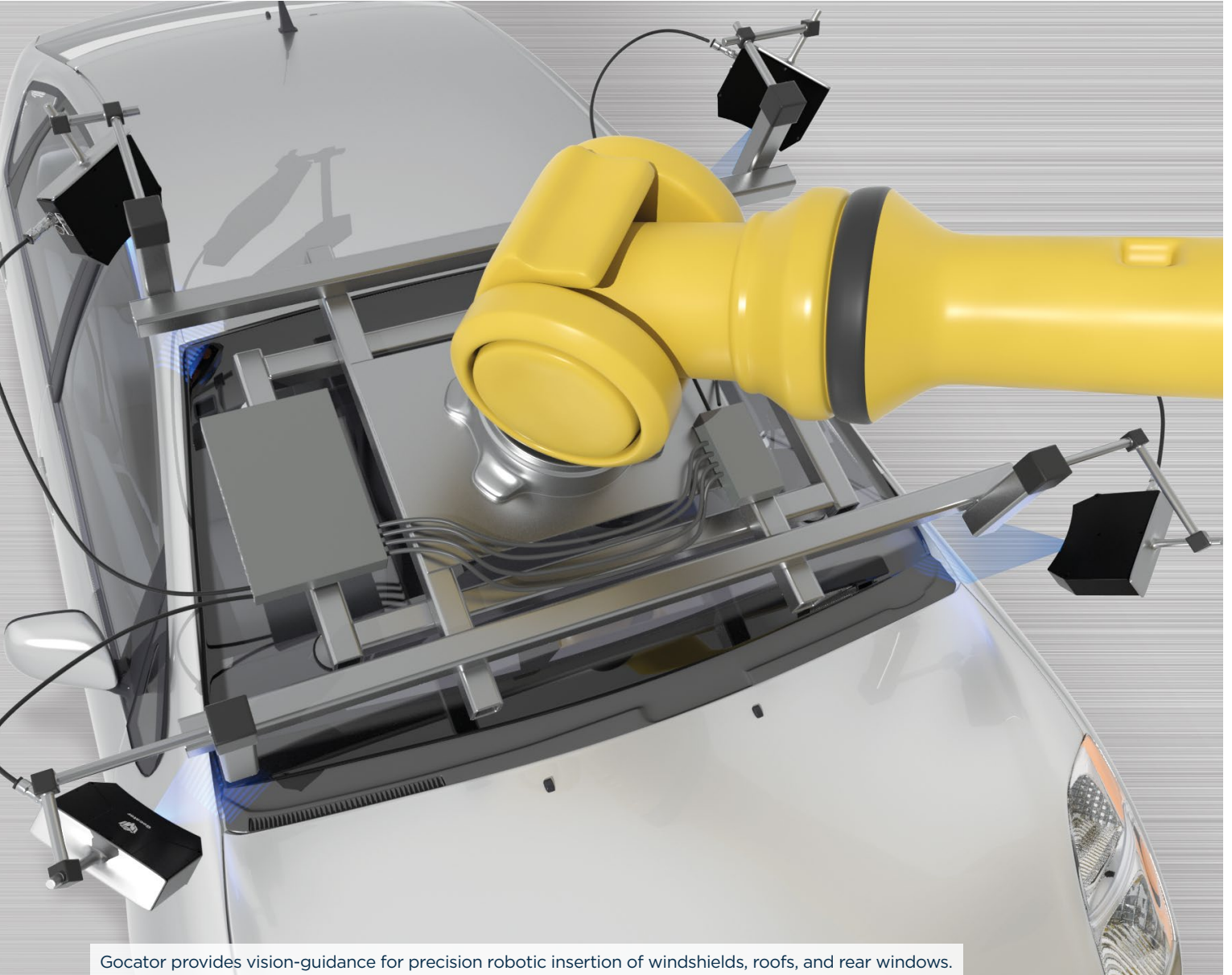

Gocator provides vision-guidance for precision robotic insertion of windshields, roofs, and rear windows.

ROBOTIC VISION GUIDANCE (RVG) SYSTEMS

Robots can be mounted with Gocator snapshot sensors in order to pick up and guide parts to critical locations for insertion (e.g., doors, roofs and windshields).

FLEXIBLE ROBOTIC MEASUREMENT

For the majority of applications, Gocator is not only responsible for guiding the robot to its correct position. It also detects and inspects finished assembly features (such as verifying panel gap and flush tolerances) and executes real-time control decisions based on the acquired data—all from inside the sensor.

GAP & FLUSH APPLICATIONS

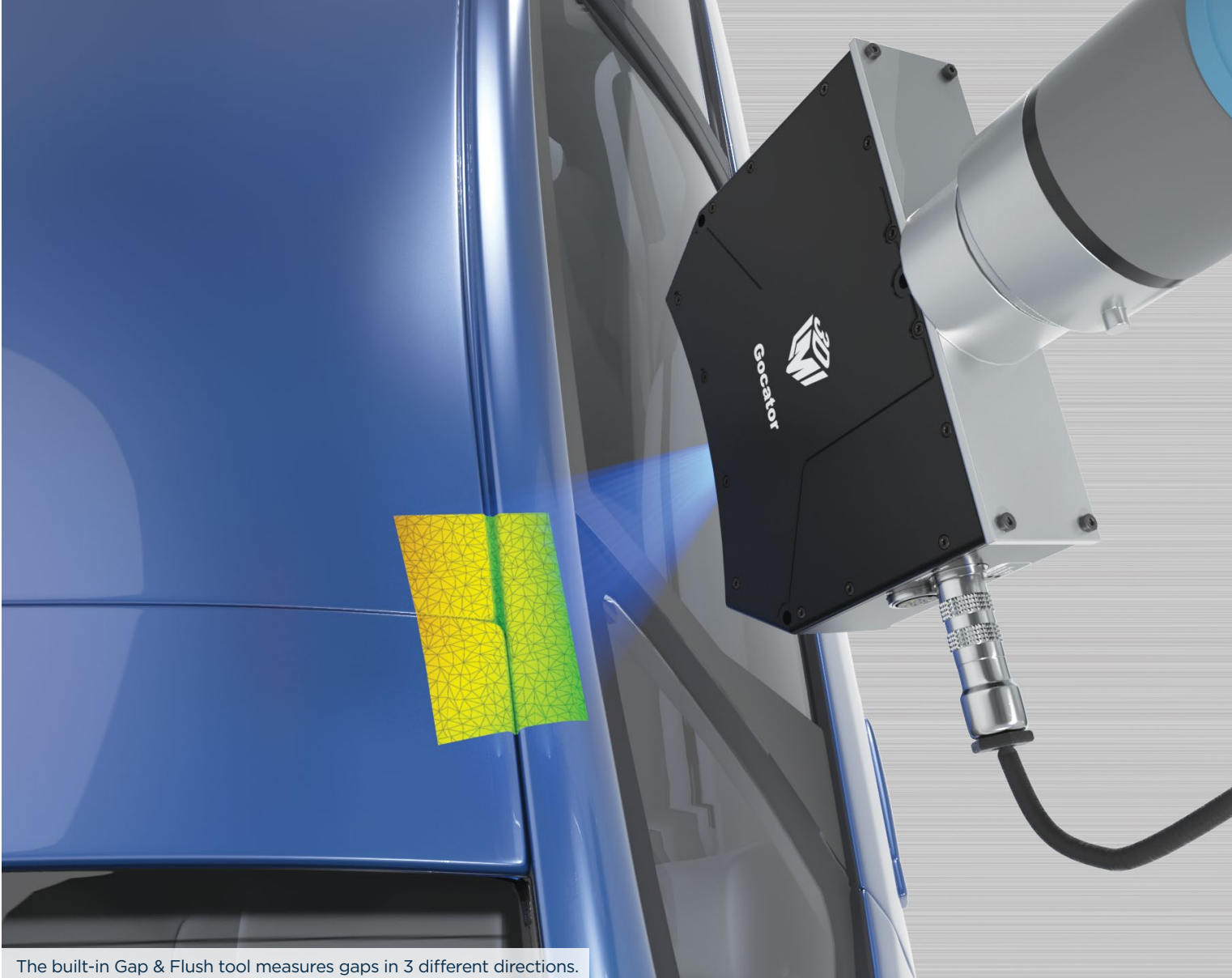

The built-in Gap & Flush tool measures gaps in 3 different directions.

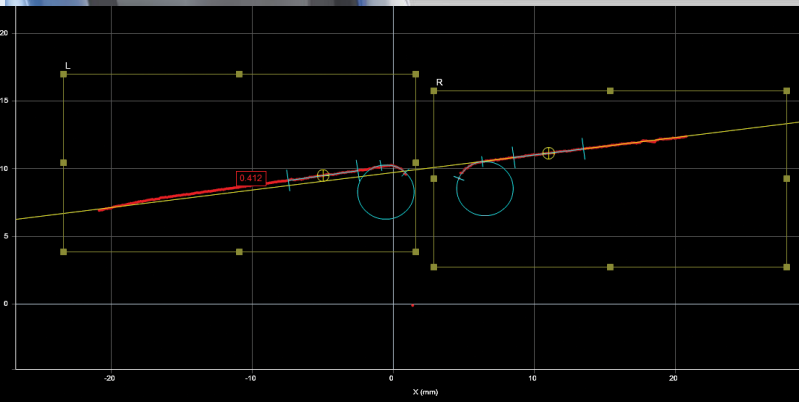
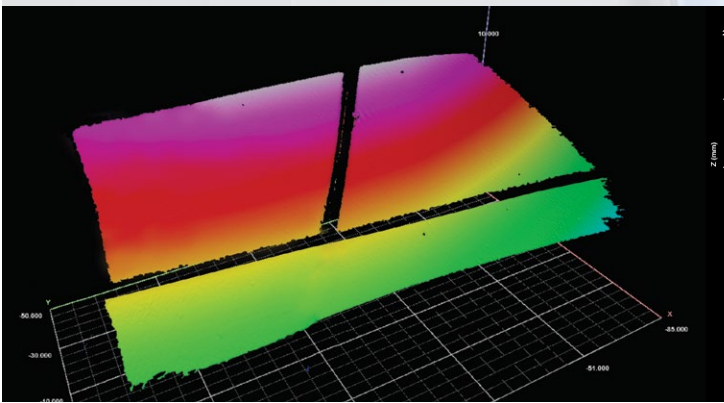

VEHICLE EMBLEM INSPECTION APPLICATIONS

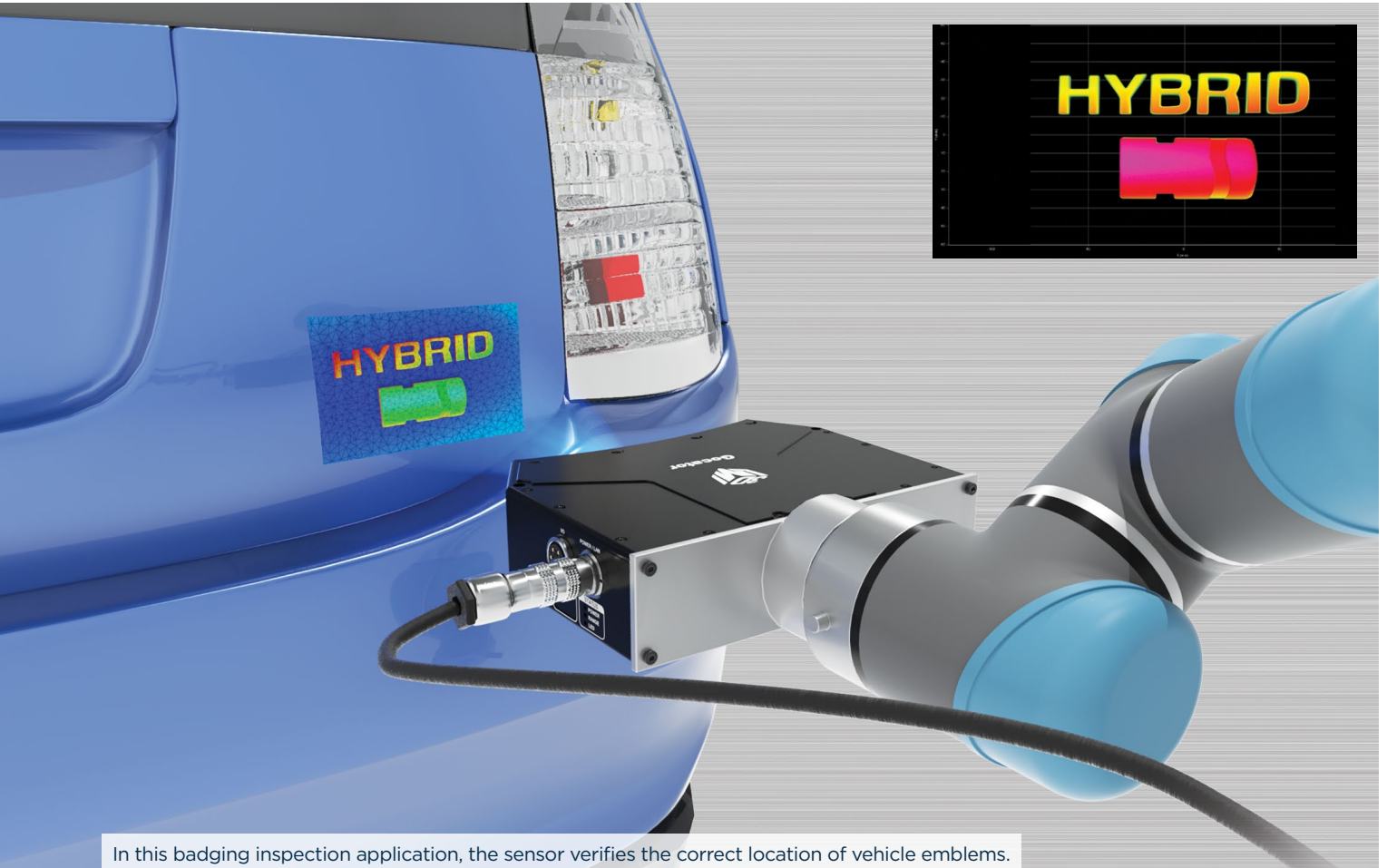

In this badging inspection application, the sensor verifies the correct location of vehicle emblems.

CASE STUDY

Network of Gocator snapshot sensors used for engine cradle inspection

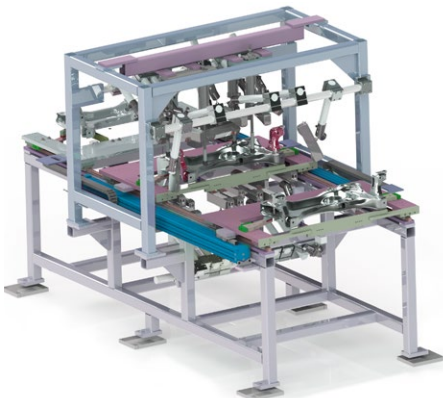

A global tier 1 automotive component manufacturer needed to verify dimensional quality of engine cradles in an inline process. The application required 32 feature inspections in under 13 seconds to meet high-volume cycle times and adherence to strict GD&T (Geometric Dimensioning and Tolerancing).

Any deviations in the cradle will lead to incorrectly fit components, which adversely affects the vehicle's camber and toe angles and can result in costly rework and recall.

Working together with Bluewrist, a trusted partner for integration and software development, 23 snapshot sensors were strategically positioned on a custom designed fixture where the manufacturer was able to inspect holes, slots, studs and trims. Scan data was then compared to the CAD design and GD&T specifications.

FIXED MEASUREMENT AND HIGH-TOLERANCE APPLICATIONS

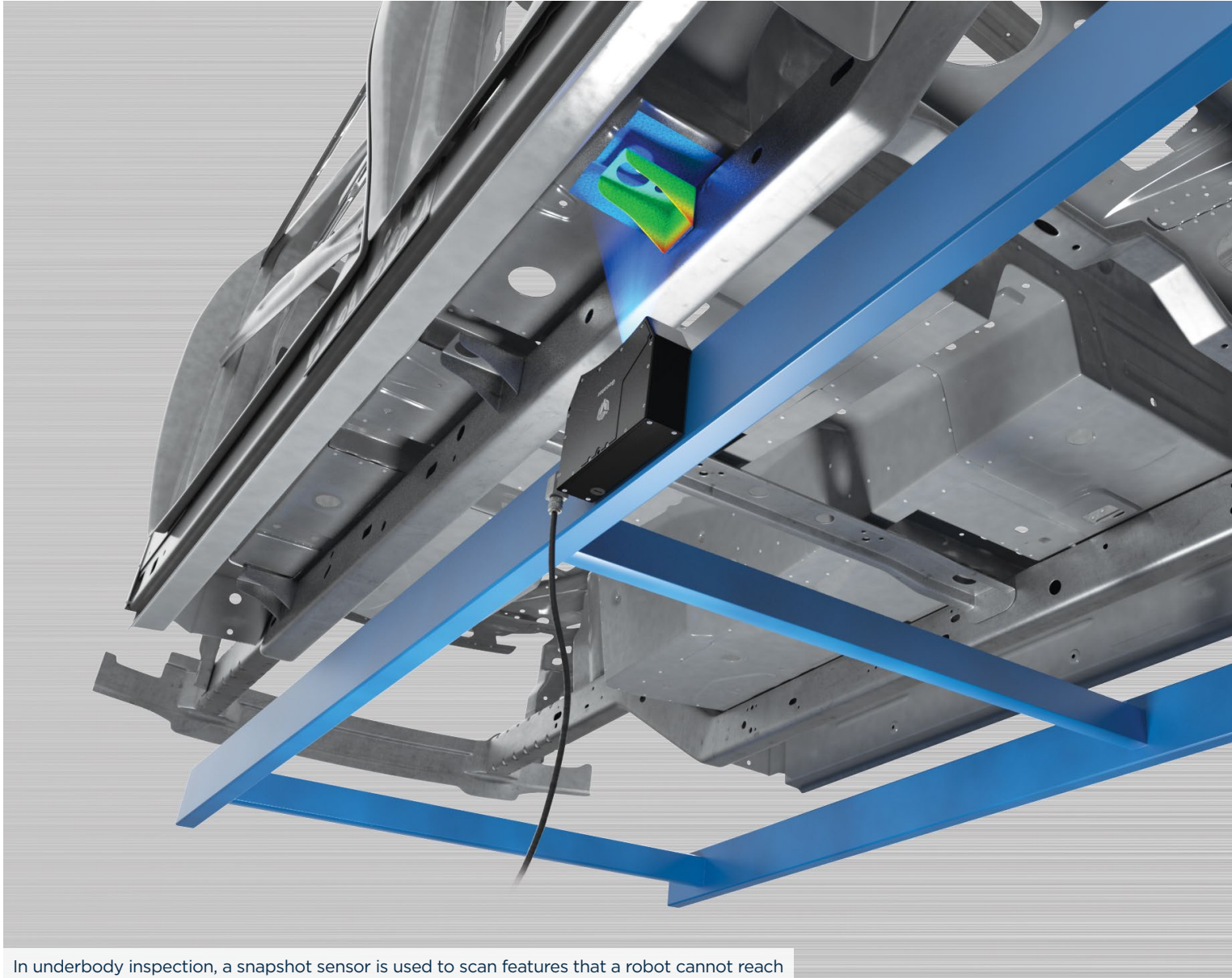

In underbody inspection, a snapshot sensor is used to scan features that a robot cannot reach

FIXED MEASUREMENT

Gocator snapshot sensors can be set up in a fixed position to scan, measure, and execute control decisions on select targets. Fixed Gocator setups can also be used to measure difficult to scan features that robotic solutions can't reach, such as occluded studs and holes found in body-in-white and underbody inspection applications.

MEASUREMENT CUSTOMIZATION

For Tier 2 and 3 automotive suppliers who need to meet high tolerances on individual components such as engine blocks, brake pads, calipers, camshafts, connector rods, etc., Gocator Development Kit (GDK) **supports the development and embedding** of custom measurement tools to satisfy any application-specific measurement requirement (e.g., Gocator Volume Checker on pg. 16-17).

GOCATOR VOLUME CHECKER

A NON-CONTACT 3D SOLUTION FOR INTERNAL COMBUSTION ENGINES

Combining our standard Gocator 3D smart snapshot sensor with customized measurement tools, **Gocator Volume Checker** calculates the volume of cylinder heads and piston bowls in small to medium-sized internal combustion engines.

- » GOCATOR SNAPSHOT SENSOR WITH CUSTOM VOLUME MEASUREMENT TOOLS
- » 3D NON-CONTACT MEASUREMENT
- » REPLACES TRADITIONAL CONTACT-BASED METHODS SUCH AS FLUIDS, PRESSURIZED AIR, ACOUSTICS
- » EASILY HANDLES SHAPE VARIATION
- » STEREO CAMERA MINIMIZES OCCLUSIONS

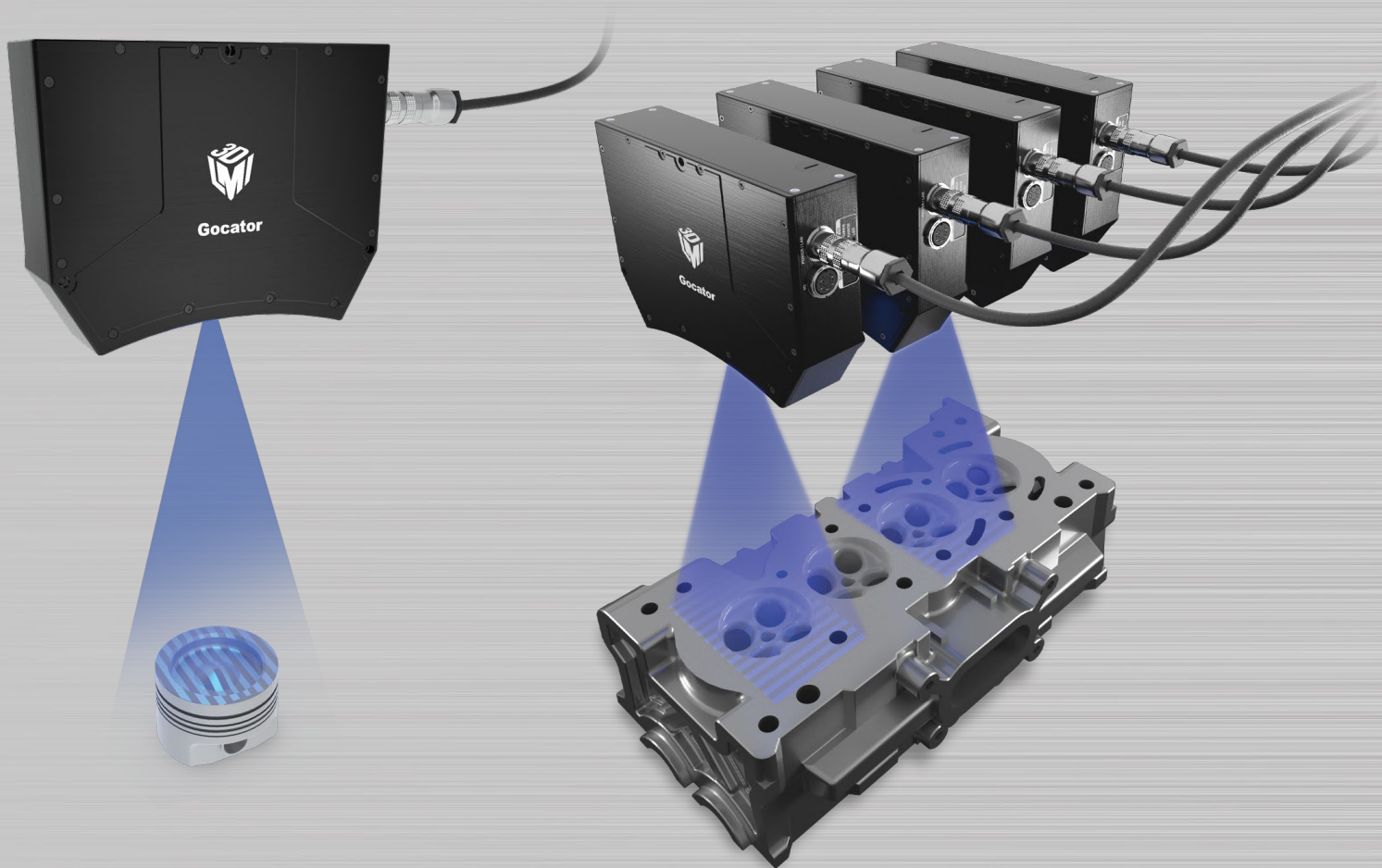

HIGH-ACCURACY MEASUREMENT OF CYLINDER HEAD AND PISTON BOWL VOLUMES

INNOVATIVE CUSTOM DESIGN

Gocator Volume Checker demonstrates the flexibility of LMI's hardware and software platform. Unique applications are solved by combining standard products with customized measurement tools.

HIGH ACCURACY MEASUREMENT

Gocator Volume Checker scans and measures volumes at an accuracy of $\pm 0.04 \text{ cm}^3$ in a cycle time of less than 5 seconds. Traditional methods can take up to 4-5 minutes to complete.

EASY TO USE WITH NO PROGRAMMING REQUIRED

Gocator's built-in user interface provides an intuitive setup experience, using any web browser, computer, or operating system. No additional software is required.

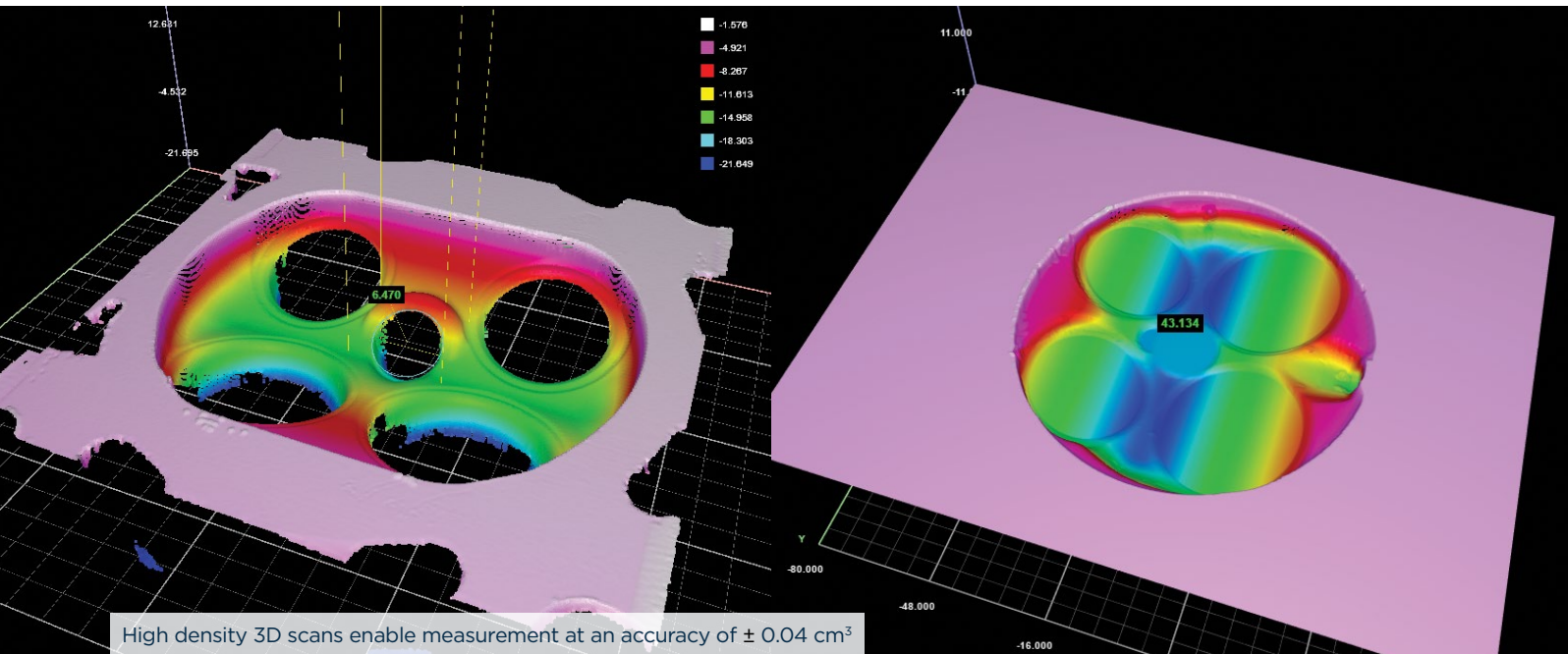

MULTIPLE I/O OPTIONS

Gocator Volume Checker measures from a high density 3D scan to verify displacement volumes and interfaces seamlessly to send pass/fail decisions to PLCs.

INDUSTRIAL PROJECTOR FOR LONG LIFETIME

The sensor uses a bright LED projector to enable short exposures so you get measurements faster. The industrial design offers an expected lifetime of up to 10 years of continuous operation.

SMALL FORM FACTOR

Gocator's compact size allows for the tight configuration of multiple sensors to achieve simultaneous measurement of multiple cylinder heads on a single engine block.

THE LMI ADVANTAGE

What makes LMI different from catalogue-based companies is that **our sole focus is 3D technology**. Four pillars support this specialized approach and drive our commitment to accelerate customer profitability by delivering the highest performing and most cost-effective 3D scanning and inspection solutions.

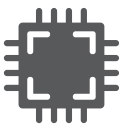

Chip Level Engineering

We design and deliver proven 3D technologies at the lowest cost.



Smart Technology

Smart sensors run standalone to produce inspection solutions out-of-the-box.



Simple User Experience

You don't need to be a rocket scientist to use our products—just point and click.



Progressive Partnerships

We build OEM solutions in support of our long term partnerships.

“

LMI provides OEMs with a flexible 3D technology platform that can be customized to meet their unique business demands. Unlike our competitors, 3D scanning and inspection is all we do, and it is this specialized knowledge and experience that helps drive profitability, reduce time to market, and open up new possibilities for our clients.

Terry Arden, CEO

”



It's Better to Be Smart.

Contact us at contact@lmi3d.com for more information on our 3D scanning and inspection solutions for the automotive industry.

AMERICAS
LMI Technologies Inc.
Burnaby, BC, Canada

EMEAR
LMI Technologies GmbH
Teltow/Berlin, Germany

ASIA PACIFIC
LMI (Shanghai) Trading Co., Ltd.
Shanghai, China



LMI Technologies has offices worldwide. All contact information is listed at lmi3d.com/contact